

ZimpleClickTM
Individual Plank Removal & Repair Guide
for planks using:

-Unilin[®] Unipush[®] profile
-i4f[®] TripleLock[®] / Click4U[®] profile

www.bodensurfaces.com

The information pertained within this guide is for reference only and does not supersede instructions from other product manufacturers or building codes.

Always consult and follow manufacturers specific installation and safety instructions BEFORE installing any products.

Boden FlooringTM bears no responsibility or liability for damage(s) resulting from the contents contained within this manual.

Information may change without notice. Visit www.bodenflooring.com for most current revision.

All tasks performed by the product user are at the own risk and liability of the user.



Removing an individual plank:

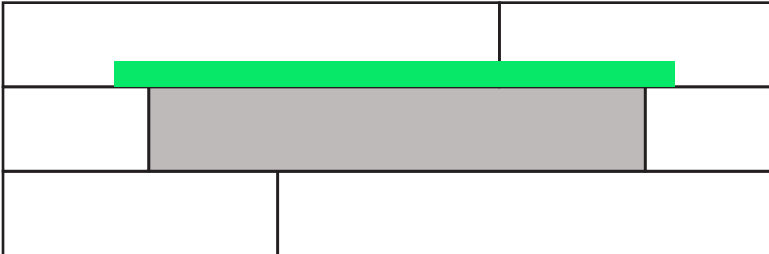

1. Using painters tape, tape around the plank which will be removed, to prevent damage to nearby planks.

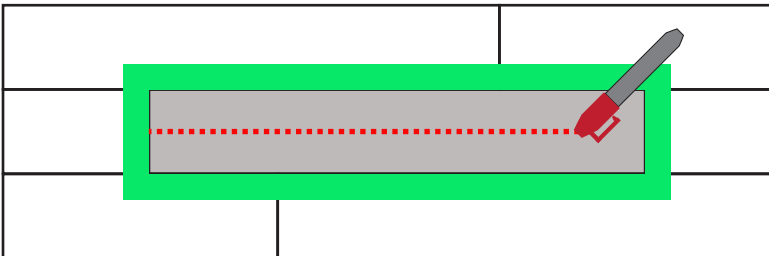

2. Mark out the center of the plank.

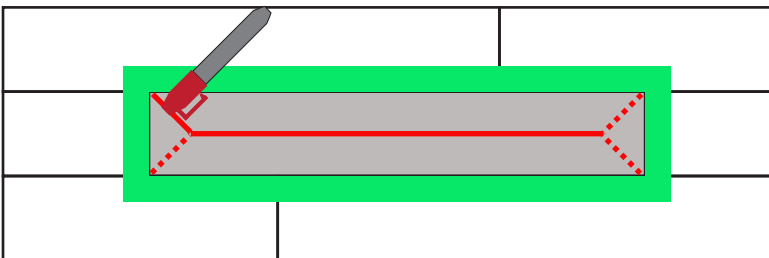

3. Using a carpenters triangle, mark out the 4 corners at a 45 degree angle so the marks intersect with the middle line.

Removing an individual plank (continued):

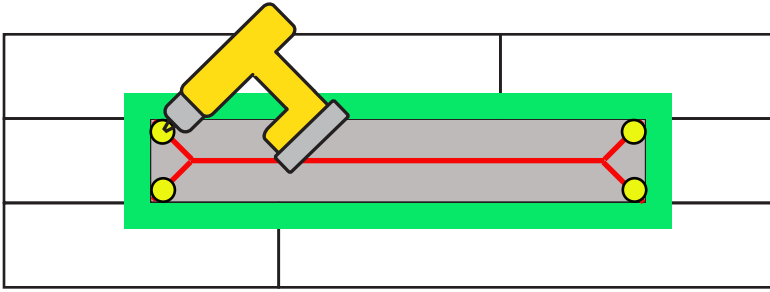

4. Using a drill bit make a 3/8" inch hole at each corner of the plank, making the holes as close to the end joints as possible.

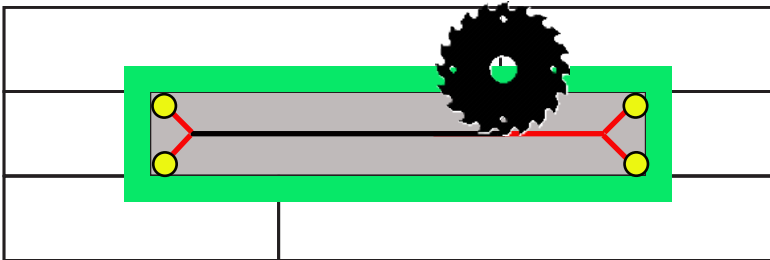

5. Using a circular saw (adjusted to the same thickness as the flooring), cut the center line.

Note: Do not cut the subfloor.

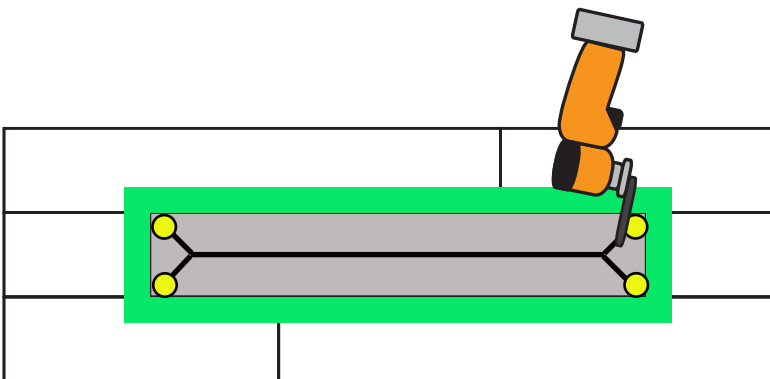

6. Using a circular saw or oscillating multi tool, cut the 45 degree lines.

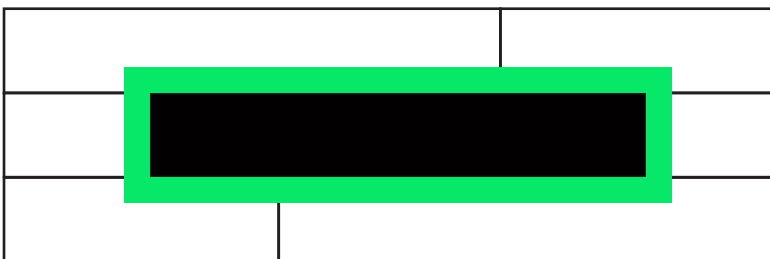

7. Gently remove the cut pieces to dislodge from the installation.

Reinstalling an individual plank:



1. Vacuum & clean the area removing all debris.

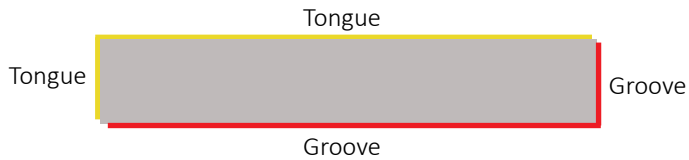

2. Obtain a new piece of flooring from the same batch.

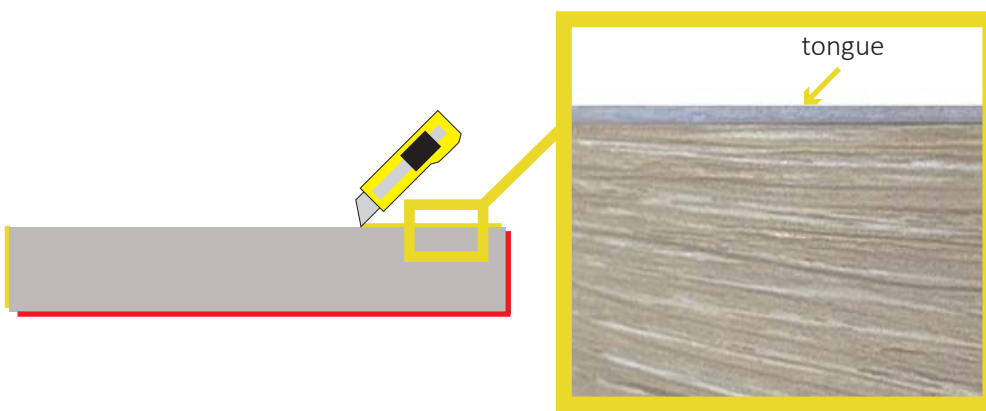

3. Cut off the exposed tongue edge from the **long side** of the plank,



4. Cut off the **nib** of the **groove** end on the short side of the plank.



Note do not cut off the groove, only cut off the **nib of the groove**.

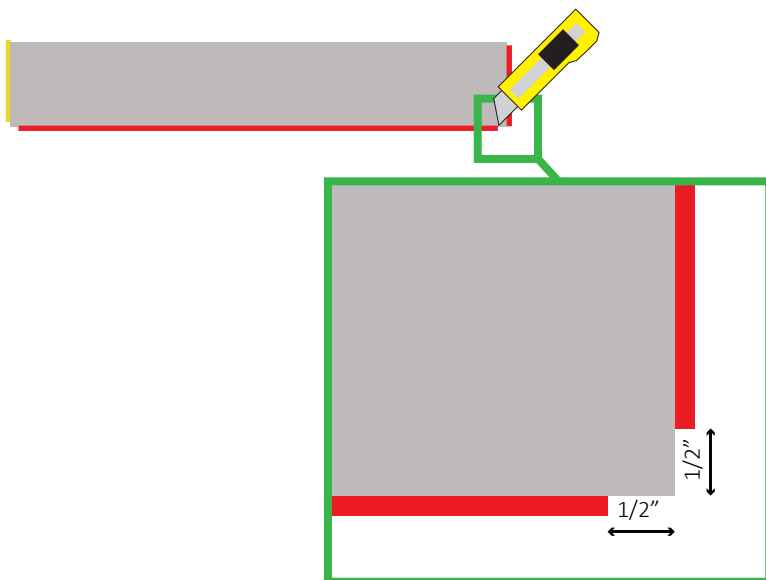

5. Cut off the groove on both the long and short sides of the plank by 1/2" only.

This will allow the plank to be inserted easier in step 7.

Reinstalling an individual plank (continued):

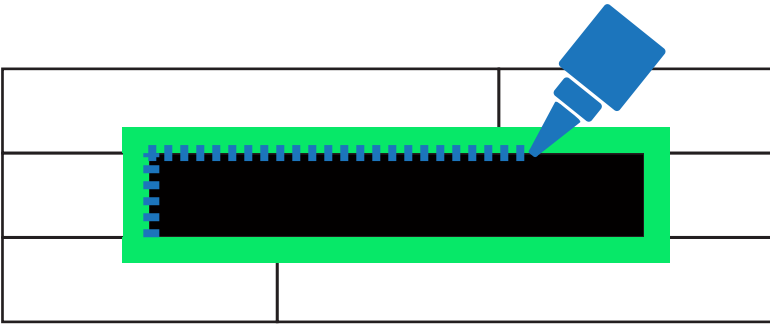

5. Apply a gel type Cyanoacrylate glue (ie crazyglue® / superglue®) into the exposed groove on both the long and short sides of the **existing** flooring.

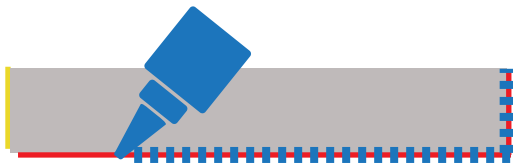

6. Apply a gel type Cyanoacrylate glue (ie crazyglue® / superglue®) into the exposed groove on both the long and short sides of the **new** piece of flooring.

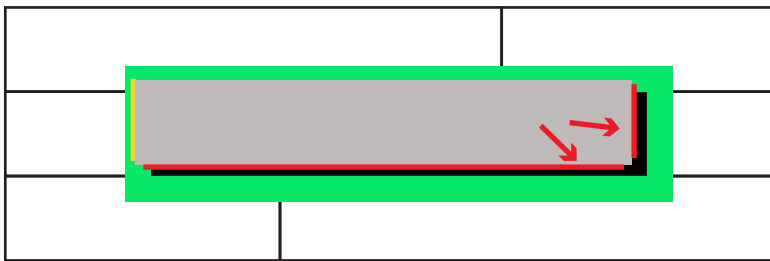

7. Insert the new flooring with the groove end of being inserted first.

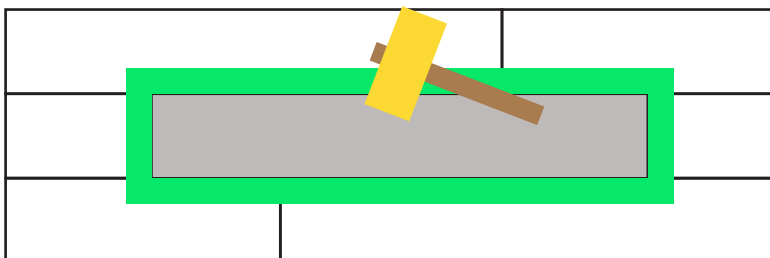

8. If necessary, use a rubber mallet to gently tap the tongue of the new flooring until it is flush with the existing flooring.

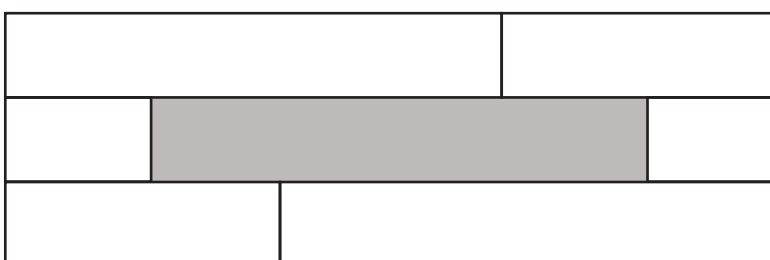

9. Remove the painters tape.

Closing Gaps

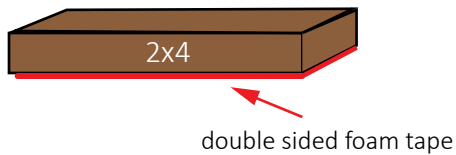
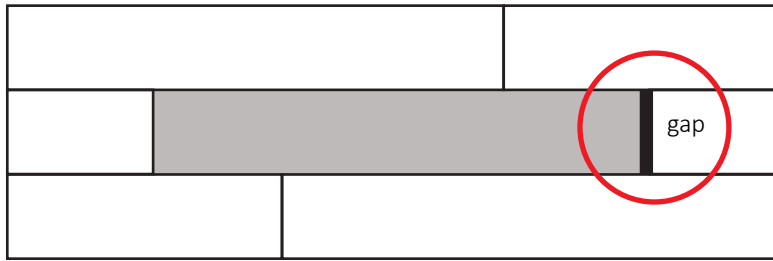

IMPORTANT:

1. If a gap has formed in your finished flooring you must determine the cause of the gap prior to repairing. Such a gap can be a result of a pinch point (not allowing the floor to float), inadequate expansion gaps at the perimeter, exposure beyond temperature limit, etc.

2. If the click profiles are not damaged and you have remedied the cause of the gap, proceed to close the gap(s). Use a wood block (example a 2x4) with double sided foam tape applied to the underside of the wood block.

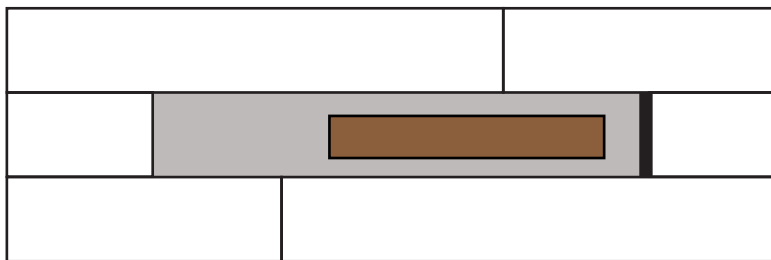

3. Set the wood onto the affected piece of flooring, with the double sided foam tape contacting the flooring.

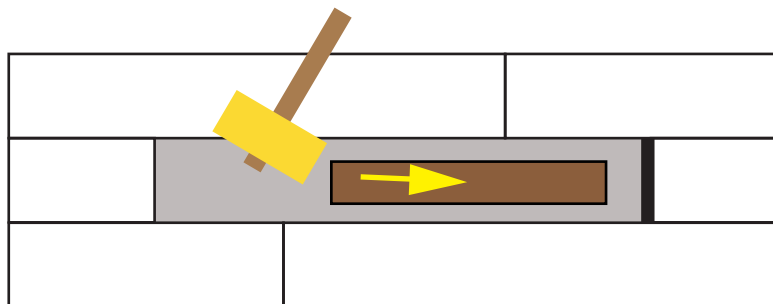

4. Using a rubber mallet, strike the wood in the direction to close the gap.
Note: Do not use excessive force or you may damage the click profiles.

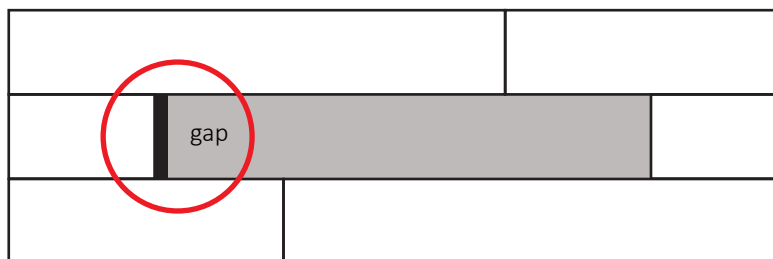

5. Once the gap is closed, it will create a gap on the opposite side of the piece. You will then need to repeat the steps to close the gaps on the pieces of flooring in that entire row.